



**Probing Solutions.
Made in Germany.**

EN



FireFly[®]

High Voltage Optically-Isolated Probe with Universal BNC Interface

>1.5 GHz, >180dB CMRR

Preliminary

Datasheet



About FireFly®

The FireFly® high voltage optically isolated probe offers industry leading performance that combines the ability to accurately resolve high bandwidth, small differential signals in the presence of large common mode voltages with its ultra-high common mode rejection performance across its entire bandwidth. With >1.5GHz bandwidth, wide differential input range, unmatched common mode rejection ratio CMRR up to >180dB (1 billion to 1 rejection), and a 60kV common mode, FireFly® is the ideal measurement solution for both GaN and SiC device characterization and system level design development.

PMK's optically isolated interface and unique compact angled probe head design are the key attributes that set FireFly® apart from the other solutions in the market, providing very stable and accurate measurements over a wide temperature range and easy access to the measurement points in tight spaces.

The compact angled probe head design allows for shorter tip cables to be used, resulting in higher signal fidelity measurements and reduced stresses placed on the measurement test point. FireFly®'s wide selection of probe tip connections and accessories offer reliable, hands-free, high-fidelity connectivity to the measurement points. Using industry standard MMCX and square pins connections allow FireFly® to easily interface to test boards that have already been design with these test points. The FireFly® probe head is powered by an easy to change, rechargeable, industry standard 18650 battery that provides continuous operation for up to 30h at room temperature. FireFly® has a universal BNC output connector and is compatible with any oscilloscope with a 50Ω input impedance or 1MΩ input impedance and a 50Ω feed-through termination, allowing FireFly® to be used on any oscilloscope in the lab. For accurate deskew, each probe's unique propagation delay is measured and added to each probe label.

Coming soon: FireFly® series will have the capability to be controlled from either remote control or the controls located on the interface box. The „PMK Probe Control“ software provides the ability for the user to control the probe remotely via a computer, and provides the user with a graphical user interface. The software is free of charge, and included with PMK's 2ch and 4ch power supplies PS2 and PS3, which are required to power the probe. The PS2 and PS3 power supplies all have a USB interface and are available with optional LAN interface. The new AP-01, 1 channel battery pack power supply, provides > 8h of portable and isolated operation, which allows the user the flexibility of where the probe can be used. The AP-01 supplies power only to the probe with no software remote control.

Factory Calibration

Annual re-calibration is recommended. ISO17025 calibration upon delivery or as re-calibration will be possible on request.

Specifications

Read the Instruction Manual before first use, and keep it for future reference. A digital copy of the latest Instruction Manual revision can be downloaded at www.pmk.de

Specifications that are marked with * are guaranteed, others are typical. Do not exceed specifications. Allow the probe to warm up for 20 minutes. The probe head and tip cables are not for handheld use. The probe can be used without the probe tip. To achieve the most accurate measurement results, review the "Getting Started" section in the Instruction Manual. This probe comes with 1 year warranty.

Electrical Specifications¹

Observe adequate spacing between probe head components and earth ground. This product is not rated for CAT II, III or IV. Do not exceed the specifications. Use original PMK power supplies only.

FireFly®	Bandwidth * (-3dB)	Rise time * (10% - 90%)	Input Attenuation	Input Impedance ²
SMA Input	> 1.5 GHz	<280 ps	1X	200 kΩ 4.0 pF
FF-MMCX-1V	> 1.5 GHz	<280 ps	1X	50 Ω ³
FF-MMCX-10V	> 1.3 GHz	<280 ps	10X	2 MΩ 3.4 pF
FF-MMCX-25V	> 1.3 GHz	<280 ps	25X	4.9 MΩ 2.1 pF
FF-MMCX-50V	> 1.3 GHz	<280 ps	50X	10 MΩ 2 pF
FF-MMCX-250V	TBD	TBD	250X	TBD
FF-WSQ-500V	TBD	TBD	500X	TBD
FF-WSQ-1000V	TBD	TBD	1000X	TBD
FF-WSQ-2500V	TBD	TBD	2500X	TBD

Maximum Rated Input Voltages ⁴

Common Mode Voltage ⁵ (Maximum Voltage to Earth)	± 60 kV (DC + Peak AC)	
No Measurement Category	Linear Input Voltage Range (DC + Peak AC) ²	Maximum Non-Destruct Differential Input Voltage (DC + Peak AC) ²
SMA Input	± 1 V	5 V
FF-MMCX-1V	± 1 V	5 V
FF-MMCX-10V	±10 V	50 V
FF-MMCX-25V	± 25 V	100 V
FF-MMCX-50V	± 50 V	100 V
FF-MMCX-250V	± 250 V	TBD
FF-WSQ-500V	± 500 V	TBD
FF-WSQ-1000V	± 1000 V	TBD
FF-WSQ-2500V	± 2500 V	TBD
Pollution Degree	2	

See next page for more Electrical Specifications and footnotes.

Electrical Specifications (Continued)

Common Mode Rejection Ratio	DC	1 MHz	100 MHz	200 MHz	500 MHz	1 GHz
SMA Input	> 180 dB	165 dB	110 dB	100 dB	90 dB	90 dB
FF-MMCX-1V	> 180 dB	145 dB	95 dB	85 dB	90 dB	90 dB
FF-MMCX-10V	> 180 dB	145 dB	85 dB	82 dB	80 dB	65 dB
FF-MMCX-25V	> 180 dB	142 dB	78 dB	75 dB	76 dB	58 dB
FF-MMCX-50V	> 180 dB	135 dB	75 dB	70 dB	70 dB	50 dB
FF-MMCX-250V	> 180 dB	TBD	TBD	TBD	TBD	TBD
FF-WSQ-500V	> 180 dB	TBD	TBD	TBD	TBD	TBD
FF-WSQ-1000V	> 180 dB	TBD	TBD	TBD	TBD	TBD
FF-WSQ-2500V	> 180 dB	TBD	TBD	TBD	TBD	TBD
DC Gain Accuracy	< 2 % ± DC Offset voltage - preliminary					
Noise (input referred)	SMA Input (1X): < 2 mV rms <i>With tip cable: (SMA Input noise) · (Tip cable input attenuation)⁷ scales proportionally to tip attenuation</i>					
DC Offset Voltage (input referred)	SMA Input (1X): < 1.5 mV (After Auto-Zero) <i>With tip cable: (SMA Input offset voltage) · (Tip cable input attenuation)⁸ scales proportionally to tip attenuation</i>					
Propagation Delay	2 m fiber cable: 15 ns <i>The probe specific value is measured and printed on interface box label, tip cable approx. 500 ps</i>					
Battery Life	> 30 h @ 22 °C – 25 °C, > 20 h @ 0 °C, >4 h @ 50 °C <i>Dependent on probe head operating temperature (Continuous Operation)</i>					
Output Termination & Coupling	50 Ω DC					
Battery Type	Protected 18650 Li-Ion, Rechargeable, 3.7V Certified					
Laser Certification	Laser Class 1 IEC/EN 60825-1:2014, US 21CFR Part 1010, US 21CFR Part 1040					

Notes:

* Guaranteed specification

¹ Determined when using a PS-02 power supply at +23°C ambient temperature.

² For input voltage and input impedance derating graphs review the FireFly® instruction manual.

³ Terminated, 50 Ω transmission line.

⁴ as defined in IEC 61010-1. Rated for indoor, dry location use only.

⁵ Galvanically isolated FireFly® probe head through fiber optic connection.

⁶ CMRR performance is >180dB below 500kHz. See CMRR graph.

⁷ Example: 10x tip FF-MMCX-10V noise = 10x SMA input noise.

⁸ Example: 10x tip FF-MMCX-10V offset = 10x SMA input offset.

Environmental Specifications

Parameter		Specification	
Temperature Range	Operating	Probe Head	0 °C to +50 °C
		Interface Box	0 °C to +40 °C
		Tip Cables & Adapters	-40 °C to +85 °C
	Non-Operating	Probe Head & Interface Box	-20 °C to +71 °C
Tip Cables & Adapters		-40 °C to +85 °C	
Maximum Relative Humidity	Operating	Probe Head	5 % to 85 % RH (relative humidity) at up to +40 °C, 5 % to 45 % RH above +40 °C up to +50 °C, non-condensing
		Interface Box	5 % to 85 % RH (relative humidity) at up to +40 °C, non-condensing
	Non-Operating	Tip Cables & Adapters	5% to 85% RH (relative humidity) at up to +85 °C, non-condensing
		Probe Head & Interface Box	5 % to 85 % RH (relative humidity) at up to +40° C, 5 % to 45 % RH above +40° C up to +71° C, non-condensing
Maximum Altitude	Operating		3000 m (9843 ft)
	Non-Operating		15000 m (49213 ft)

Physical Specifications

Parameter	Specification	
Weight	Probe	325 g
	Tip Cable	11 g
Length	Tip Cable	9.5 cm (3.74")
	Fiber Cable	2 m (6.56 ft)
Connectors	Probe	Input: SMA (Female) – Probe Head Output: BNC (Male) - Interface Box

Dimensions

The dimensions shown are in mm. Drawings from the probe tips are coming soon. If the needed drawing is missing, please contact us via sales@pmk.de

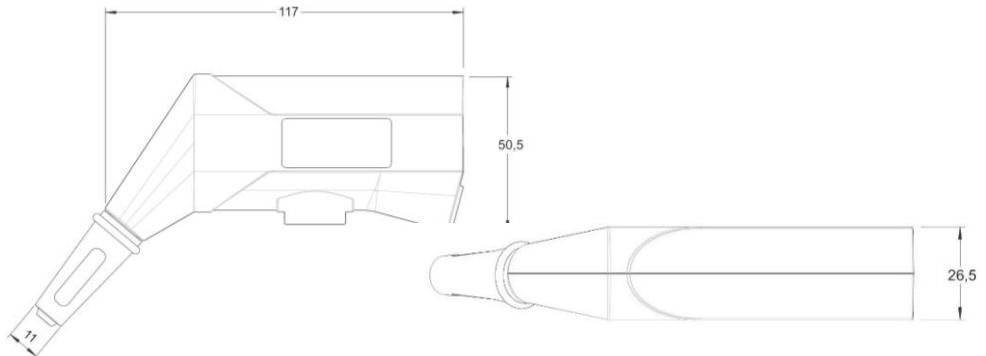

Typical Common Mode Rejection Ratio (CMRR)

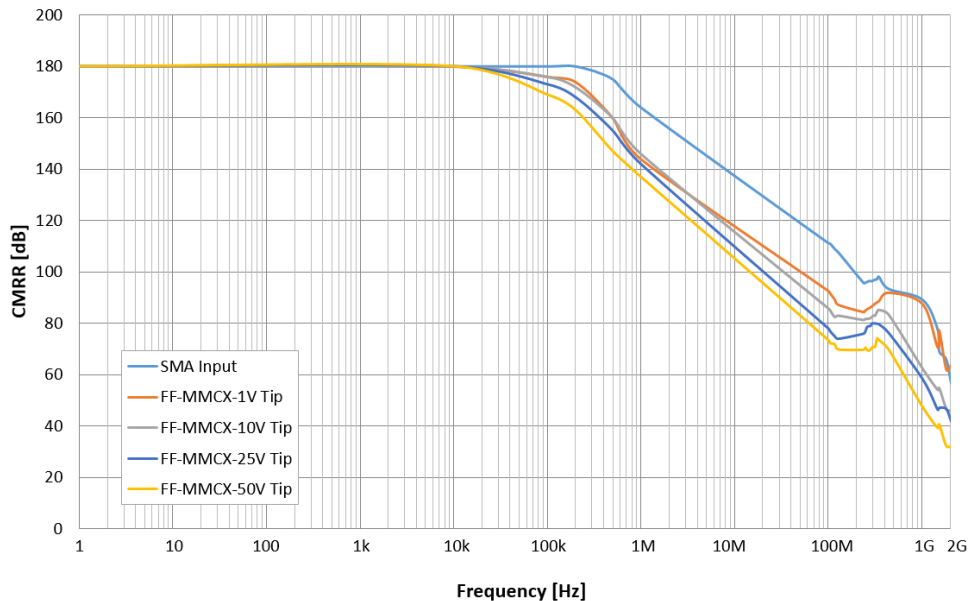

Typical Maximum Differential Input Voltage (CW)



Note that the maximum input voltage rating of the probe decreases as the frequency of the applied signal increases.

The maximum input voltage derating is coming soon.

Typical Frequency Response

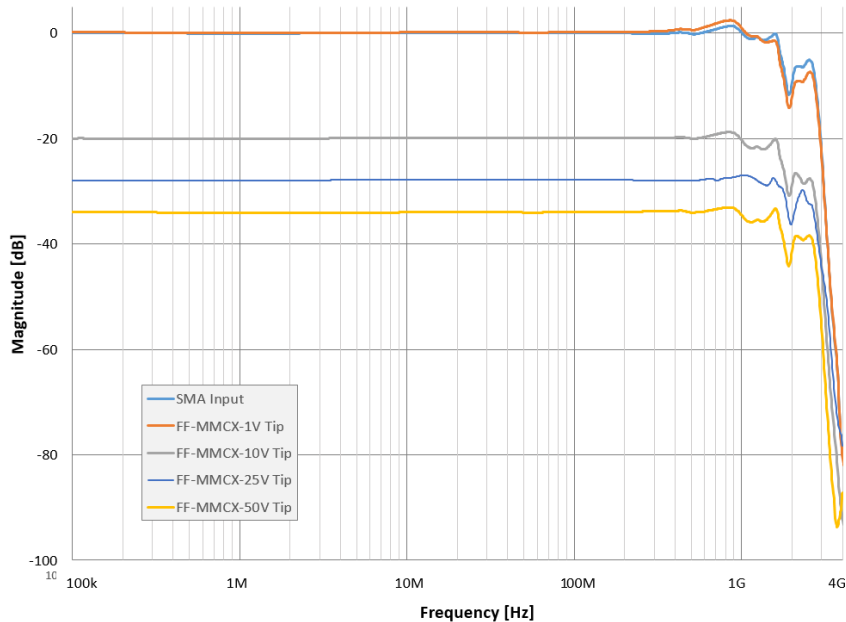

Typical Pulse Response

The graphs are normalized to 1 for better comparison.

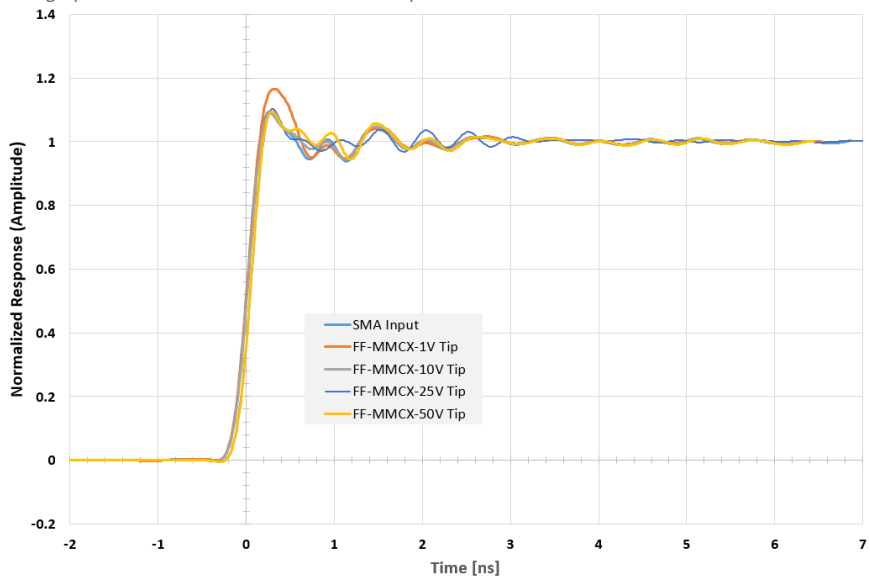

Typical Differential Input Impedance



Note that the maximum input voltage rating of the probe decreases as the frequency of the applied signal increases.

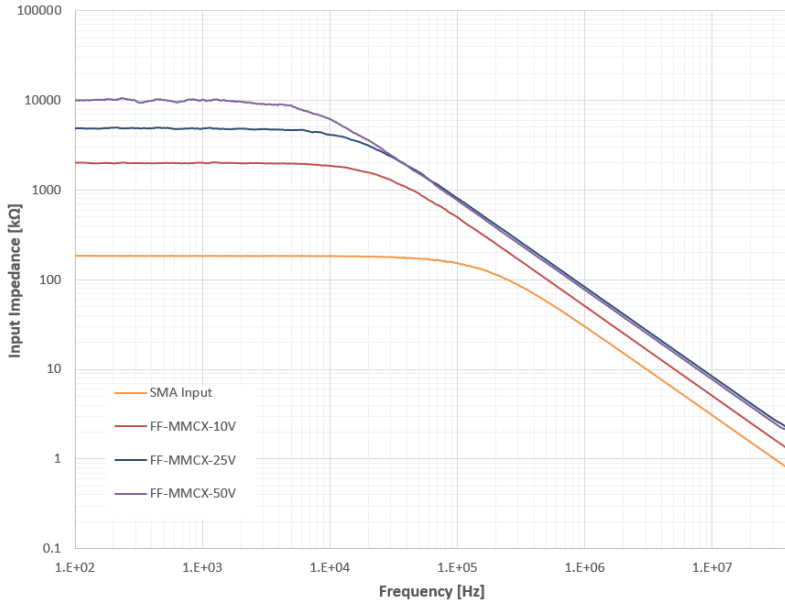

Scope of Delivery

Not all required items are included in the scope of delivery of the base probe FireFly® FF-1500. See Ordering Information to configure your individual probing solution and select a required PMK power supply. The following accessories are included in the scope of delivery.

- FireFly® FF-1500 base Probe, $\pm 1V$ input range
- 2x 18650 rechargeable Lithium Ion batteries
- USB Wall charger + USB cable (for battery charging) *Charger type may vary by region*
- Interface box probe connection cable (0.5m), 890-520-900
- Probe head holder 2-Footer (Bi-Pod), FF-2FOOTER
- Set cable coding rings (3x4 colors)
- Instruction Manual



The accessories for this probe series have been safety tested. Do not use any other accessories, batteries or power supplies than what is recommended.

Ordering Information

Step 1: Select Base Probe

FF-1500	FireFly® optical isolated probe, 1.5GHz, >180dB, 2m fiber cable (2 batteries and 2 footer included, required power supply to be ordered separately)
----------------	---

Step 2: Select Probe Tip Cables

The probe tip cables are interchangeable without requiring any tools. The probe head SMA input range is $\pm 1V$ with no attenuation.

FF-MMCX-1V	FireFly® probe tip cable, MMCX, $\pm 1V$, >1.5GHz, 1x attenuation, 50 Ω terminated for shunt measurements
FF-MMCX-10V	FireFly® probe tip cable, MMCX, $\pm 10V$, >1.3GHz, 10x attenuation
FF-MMCX-25V	FireFly® probe tip cable, MMCX, $\pm 25V$, >1.3GHz, 25x attenuation
FF-MMCX-50V	FireFly® probe tip cable, MMCX, $\pm 50V$, >1.3GHz, 50x attenuation
FF-MMCX-250V	FireFly® probe tip cable, MMCX, $\pm 250V$, TBD GHz, 250x attenuation
FF-WSQ-500V	FireFly® probe tip cable for 5.08mm square pins, $\pm 500V$, TBD GHz, 500x attenuation
FF-WSQ-1000V	FireFly® probe tip cable for 5.08mm square pins, $\pm 1000V$, TBD GHz, 1000x attenuation
FF-WSQ-2500V	FireFly® probe tip cable for 5.08mm square pins, $\pm 2500V$, TBD GHz, 2500x attenuation

Step 3: Select Connectivity Accessories

Observe the frequency derating of each accessory. Observe maximum input voltage of the probe's input. Do not use any other accessories.

FF-SQ-MMCX5

5x MMCX to 2x 0.025" (0.635mm) socket, -40°C to +125°C



FF-HTSPAD-MMCX3

3x MMCX solder-in cable adapter HT, 50 Ω RF micro coax to flex solder-in pad, -40°C to +155°C (green = 0 Ω , yellow = 36 Ω , red = 75 Ω)



FF-HTS-MMCX2

2x MMCX solder-in cable adapter HT, MMCX socket with 50 Ω RF micro coax cable and open end, -40°C to +155°C



FF-UFL-MMCX2

2x MMCX cable adapter, MMCX socket with 50 Ω RF micro coax cable to U.F.L plug, -40°C to +125°C







FF-2XR-MMCX

MMCX to 2x XR Mini-Hook





Continues on next page.

Observe the frequency derating of each accessory. Observe maximum input voltage of the probe's input. Do not use any other accessories.

972416100	2-pole test clip SMD for use with FF-SQ-MMCX5	
P25-2	Pico Hook™ red for use with FF-SQ-MMCX5	
P25-0	Pico Hook™ black for use with FF-SQ-MMCX5	
D010031	50Ω BNC feed-through for 1MΩ input oscilloscopes	

Step 4: Select Positioning System

FF-2FOOTER	Probe positioner 2-Footer (Bipod), included in probe's scope of delivery	
FF-3DPOS200	3D positioner with steel base, 200 mm span width and FireFly® probe holder, max 10kV	
FF-HAL10kV-3	FireFly® probe holder, max 10kV for use with PMK's 3D Probe Positioning Systems and SKID Probes and PCB Board holder systems, no stand-alone use	

Step 5: Select Power Supply

A PMK power supply PS2 or PS3 is required for using the probe.



The power supply pin assignment is different from other power supplies. Use only original PMK power supplies with PMK probes.

889-09V-PS2	PS-02 (2 channels, with USB interface for remote control)
889-09V-PS2-L	PS-02-L (2 channels, with LAN and USB interface for remote control)
889-09V-PS3	PS-03 (4 channels, with USB interface for remote control)
889-09V-PS3-L	PS-03-L (4 channels, with LAN and USB interface for remote control)
889-09V-AP01	AP-01 (battery pack, 1 channel, no remote control)
890-520-900	Power supply cable (0.5 m), included in probe's scope of delivery
890-520-915	Power supply cable (1.5 m)

Observe Connector Pin-Out for PMK power supply cables

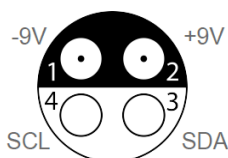

Step 6: Select Accredited Calibration

KAL-DAKKS-FF	ISO 17025 (re-)calibration
--------------	----------------------------

Step 7: Select Additional Accessories

D010031	50Ω BNC feedthrough for use with 1MΩ oscilloscope inputs, 0.5W
---------	--

Coming Soon / In Development

New connectivity solutions

Power-Over-Fiber adapter

If you need any non-published accessory, please contact us via sales@pmk.de

Copyright © 2023 PMK - All rights reserved.

Information in this publication supersedes that in all previously published material.
Specifications are subject to change without notice.

Informationen in dieser Anleitung ersetzen die in allen bisher veröffentlichten Dokumenten.
Änderungen der Spezifikationen vorbehalten.